

SPACECRAFT COMPONENTS CORP.

Your Connector Consultant Since 1962

MIL-DTL-26482

DUST CAPS & DUMMY RECEPTACLES

MS3180

MS3181

MS3115



- ▶ Military Approved
- ▶ Special Platings Available
- ▶ Extensive Inventory



SPACECRAFT
COMPONENTS CORP.

DUST CAPS & DUMMY RECEPTACLES - MIL-DTL-26482

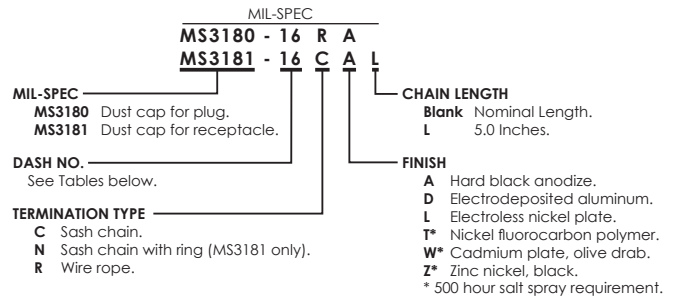
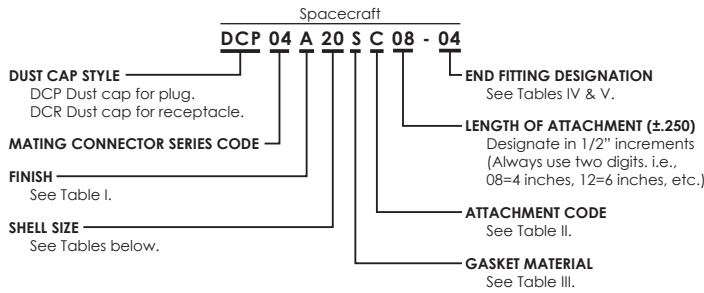

Dust Cap for Plug

MS3180 DCP04

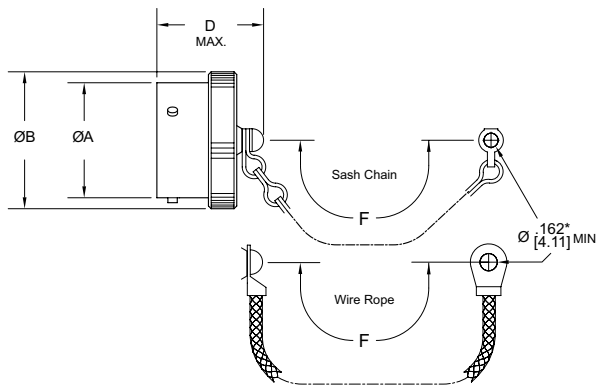

DASH NO.	SHELL SIZE	A MAX.	B MAX.	D MAX.	F +.500 [12.70] -.250 [6.35]
8C or 8R	8	.474 [12.04]	.719 [18.26]	.781 [19.84]	3.00 [76.20]
10C or 10R	10	.591 [15.01]	.844 [21.44]	.781 [19.84]	3.00 [76.20]
12C or 12R	12	.751 [19.08]	1.000 [25.40]	.781 [19.84]	3.50 [88.90]
14C or 14R	14	.876 [22.25]	1.125 [28.57]	.781 [19.84]	3.50 [88.90]
16C or 16R	16	1.001 [25.43]	1.250 [31.75]	.781 [19.84]	3.50 [88.90]
18C or 18R	18	1.126 [28.60]	1.375 [34.92]	.781 [19.84]	3.50 [88.90]
20C or 20R	20	1.251 [31.78]	1.500 [38.10]	.844 [21.44]	4.00 [101.6]
22C or 22R	22	1.376 [34.95]	1.625 [41.27]	.844 [21.44]	4.00 [101.6]
24C or 24R	24	1.501 [38.13]	1.750 [44.45]	.875 [22.22]	4.00 [101.6]

1. Dimensions in brackets [] are in millimeters.
*.162 min. only applicable for MS3180. For DCR04 use end fitting code.

Dust Cap for Receptacle

MS3181 DCR04

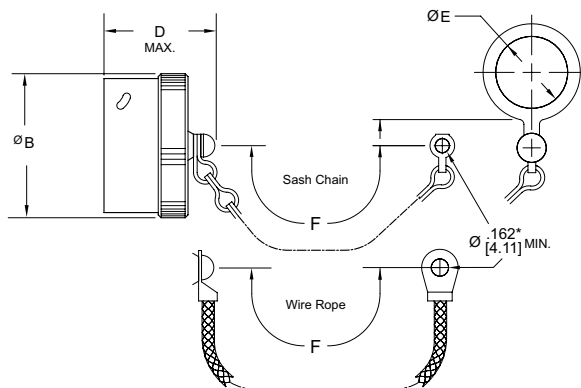

DASH NO.	SHELL SIZE	B MAX.	D MAX.	E* MIN.	F +.500 [12.70] -.250 [6.35]
8C, 8N, 8R	8	.734 [18.64]	.844 [21.44]	.578 [14.68]	3.00 [76.20]
10C, 10N, 10R	10	.859 [21.82]	.844 [21.44]	.703 [17.86]	3.00 [76.20]
12C, 12N, 12R	12	1.000 [25.40]	.844 [21.44]	.891 [22.63]	3.50 [88.90]
14C, 14N, 14R	14	1.125 [28.57]	.844 [21.44]	1.016 [25.81]	3.50 [88.90]
16C, 16N, 16R	16	1.250 [31.75]	.844 [21.44]	1.141 [28.98]	3.50 [88.90]
18C, 18N, 18R	18	1.375 [34.92]	.844 [21.44]	1.266 [32.16]	3.50 [88.90]
20C, 20N, 20R	20	1.500 [38.10]	.844 [21.44]	1.391 [35.33]	4.00 [101.6]
22C, 22N, 22R	22	1.625 [41.27]	.844 [21.44]	1.516 [38.51]	4.00 [101.6]
24C, 24N, 24R	24	1.750 [44.45]	.875 [22.22]	1.641 [41.68]	4.00 [101.6]

1. Dimensions in brackets [] are in millimeters.
*.162 min. of "E" dimension only applicable for MS3181. For DCP04 use end fitting code.

Dummy Receptacle

MS3115 DRP04

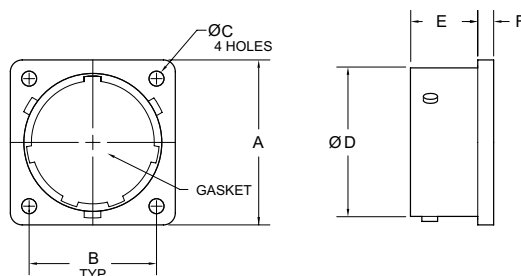
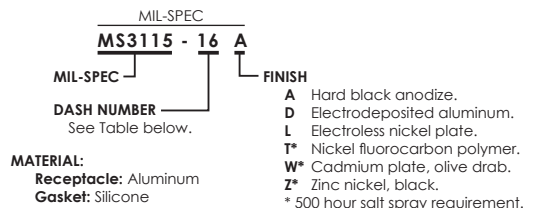
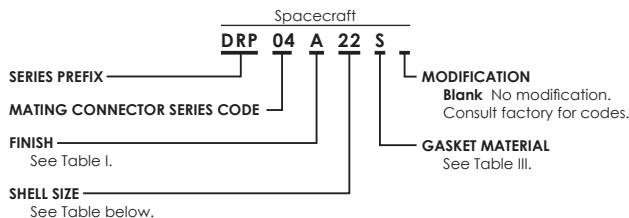

DASH NO.	A MAX.	B	C ±.005 [±0.13]	D +.001 -.005 [+0.03] [-0.13]	E +.031 -.000 [+0.79] [-0.00]	F ±.016 [±0.41]
8	.828 [21.03]	.594 [15.09]	.120 [3.05]	.473 [12.01]	.462 [11.73]	.062 [1.57]
10	.954 [24.23]	.719 [18.26]	.120 [3.05]	.590 [14.99]	.462 [11.73]	.062 [1.57]
12	1.047 [26.59]	.812 [20.62]	.120 [3.05]	.750 [19.05]	.462 [11.73]	.062 [1.57]
14	1.141 [28.98]	.906 [23.01]	.120 [3.05]	.875 [22.22]	.462 [11.73]	.062 [1.57]
16	1.234 [31.34]	.969 [24.61]	.120 [3.05]	1.000 [25.40]	.462 [11.73]	.062 [1.57]
18	1.328 [33.73]	1.062 [26.97]	.120 [3.05]	1.125 [28.57]	.462 [11.73]	.062 [1.57]
20	1.453 [36.88]	1.156 [29.36]	.120 [3.05]	1.250 [31.75]	.556 [14.12]	.094 [2.39]
22	1.578 [40.08]	1.250 [31.75]	.120 [3.05]	1.375 [34.92]	.556 [14.12]	.094 [2.39]
24	1.703 [43.26]	1.375 [34.92]	.147 [3.73]	1.500 [38.10]	.589 [14.96]	.094 [2.39]

1. Dimensions in brackets [] are in millimeters.



**SPACECRAFT
COMPONENTS CORP.**

3040 Clayton Street
North Las Vegas, NV 89032

Phone: 702.851.7600
Fax: 702.851.7620

Email: salesinfo@spacecraft.com
Web: www.spacecraft.com

MIL-DTL-26482 - DUST CAPS & DUMMY RECEPTACLES

SPACECRAFT CODES FOR:
 DUST CAP FOR PLUG: **DCP04**
 DUST CAP FOR RECEPTACLE: **DCR04**
 DUMMY RECEPTACLE: **DRP04**

TABLE I. FINISH CODES
 CONSULT FACTORY FOR OTHER AVAILABLE FINISHES

Spacecraft Code	Finish	Specification(s)
H	● Anodize, Black	AMS-A-8625, Type II, Class 2
B	● Cadmium Plate, Black	AMS-QQ-P-416, Type II, Class 3
X	● Cadmium Plate, Bright Over Electroless Nickel	AMS-QQ-P-416, Type I, Class 3 ASTMB 733-90, SC2, Type I, Class 5 over AMS-C-26074, Class 4, Grade B
E	● Cadmium Plate, Gold Iridite, Over Electroless Nickel	MIL-C-5541, Class 3 AMS-QQ-P-416, Type II, Class 3 over AMS-C-26074, Class 4, Grade B
C	● Cadmium Plate, Olive Drab	AMS-QQ-P-416, Type II, Class 3, 48 Hours
A	● Cadmium Plate, Olive Drab Over Electroless Nickel	1000 Hour Corrosion Resistance
N	● Electroless Nickel	AMS-C-26074, Class 4, Grade B
L	● Zinc Cobalt, Dark Olive Drab	96 Hour Corrosion Resistance
P	● Passivated, Stainless Steel	AMS-QQ-P-35
T	● Nickel, Fluorocarbon Polymer	500 Hour Corrosion Resistance
W	● Zinc Nickel, Black	ASTM B841 Type D

TABLE II. ATTACHMENT CODES

Attachment Code	Description
A	No Attachment Required
B	Bead Chain, Brass, Nickel Plated
C	Sash Chain, SST, Passivated
D	Bead Chain, SST, Passivated
E	Bead Chain, Brass, Cadmium, Olive Drab Plated
F	Bead Chain, Brass, Unfinished
I	Bead Chain, Brass, Black Oxide Finish
N	Wire Rope, No Jacket
P	Wire Rope, Polyurethane Jacket with Terminal
R	Wire Rope, SST, PVC Covered, Green Color
T	Wire Rope, SST, Teflon Covered, Natural Cover
U	Wire Rope, SST, Nylon Covered, Brown Color
V	Wire Rope, SST, Viton Covered, Black Color
W	Nylon Cord, Green Color, SST Terminal

TABLE III. GASKET MATERIAL CODES

Material Code	Material Description
A	Fluorosilicone, Blue
N	Neoprene, Black, MIL-R-3065
O	None Required
S	Silicone, Red, ZZ-R-765
C	Conductive Silicone

TABLE IV. EYELET END FITTING STYLES AND SIZES
 (NOT USED WITH ATTACHMENT CODE A)

Dash No. Code	Y Ref. Dia.
00	No Eyelet
01	.125
02	.141
03	.167
04	.188
05	.219
06	.250
07	.156
08	.121

USED WITH ATTACHMENT CODES:

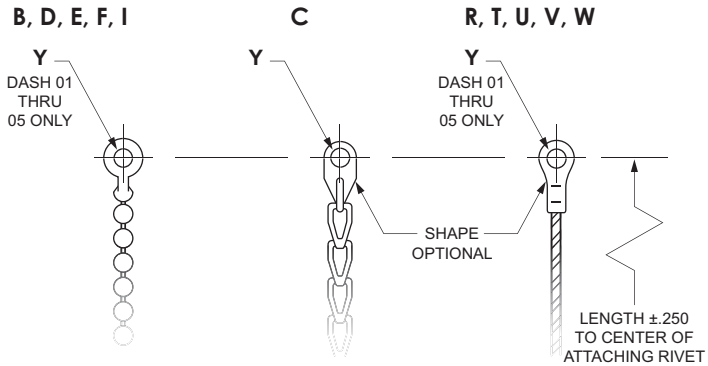
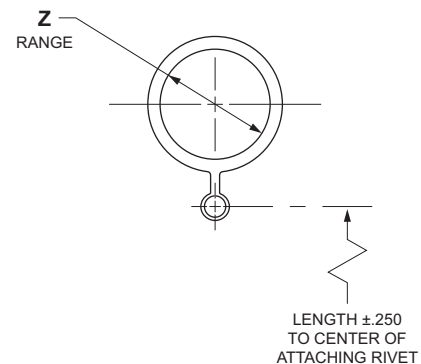

TABLE V. RING END FITTING SIZES
 (NOT USED WITH ATTACHMENT CODE A)

DASH NO. CODE	Z RANGE	DASH NO. CODE	Z RANGE	DASH NO. CODE	Z RANGE
33	.401 - .391	15	1.072 - 1.052	24	2.088 - 2.078
34	.454 - .444	16	1.198 - 1.178	25	2.151 - 2.141
35	.464 - .454	17	1.322 - 1.302	26	2.276 - 2.266
36	.526 - .516	18	1.448 - 1.428	27	2.338 - 2.328
11	.604 - .584	19	1.572 - 1.552	28	2.401 - 2.391
37	.651 - .641	20	1.698 - 1.678	29	2.526 - 2.516
12	.729 - .709	21	1.822 - 1.802	30	2.651 - 2.641
13	.885 - .865	22	1.948 - 1.928	31	2.901 - 2.891
14	.948 - .918	23	2.026 - 2.016	32	3.026 - 3.016

USED WITH ATTACHMENT CODES:
 B THRU W



SPACECRAFT COMPONENTS CORP.

Your Connector Consultant Since 1962

Try Our Other Connector Products



SCP 5015 STYLE
CONNECTORS
(CATALOG 102)



SCPT 26482 STYLE
SC1 38999 SERIES I
SC2 38999 SERIES II
SC39 38999 SERIES III
(CATALOG 202)



SCPB SERIES
(CATALOG 302)



CONNECTOR
ACCESSORIES
(CATALOG 402)



CONNECTORS
WITH INTEGRATED
BACKSHELLS
(CATALOG 601)



Get All of Our Catalogs & Product Brochures on One Disc



SPACECRAFT COMPONENTS CORP.



Headquarters

3040 Clayton Street
North Las Vegas, NV 89032

Phone: 702.851.7600
Fax: 702.851.7620

Email: salesinfo@spacecraft.com
Web: www.spacecraft.com

Florida Office

4577 Nob Hill Road
Suite 106
Sunrise, FL 33351
Tel: 954.748.4540
Fax: 954.748.4128

Arizona Office

519 W. Lone Cactus Dr.
Suite 401
Phoenix, AZ 85027
Tel: 623.580.1162
Fax: 623.580.1165

Italy Office

Spacecraft Components, sp A
Milan, Italy
+39 [335] 719.4512

Mexico Office

Av. Constituyentes 13-6 Col. Pueblo Nuevo
Queretaro, Qro 76900
+52 442 341 69 63

COMING SOON...
All Plastic Connectors
CATALOG 701

APR 2013
SF-143

COMPILED AND PRODUCED BY SPACECRAFT COMPONENTS CORP.
©2012 SPACECRAFT COMPONENTS CORP., NORTH LAS VEGAS, NV 89032